



- Island Mode and synchronised to Mains Mode operation, Two Functions - One Solution
- Over/Under Frequency
- Over/Under Voltage
- Phase Imbalance
- Triple Relay Operation
- Trip Indication Outputs
- Adjustable Supervision Delay

Specifications

Auxiliary Voltage:	Self powered from monitored voltage input
Optional Auxiliary Voltage:	24 or 36-110VDC (Fuse 2A)
Monitored Voltage input:	100-120, 200-240, 380-415 or 440-460VAC, 40-70Hz (Fuse 0,5A)
Frequency Range:	45-65Hz
Relay Standard:	Latching relays as standard. User selectable to 3-180sec auto reset of alarms
Contact Rating:	AC: 100VA - 250V/2A max. DC: 50W - 100V/1A max.
Open Collector Outputs:	30V DC max. - 500mA max.
Settings:	See page 2 and 3
Adjustments:	Supervision Delay: 0,1-10,0 secs (All other adjustments are made via the hand held controller HHP1 or HHP2)
Internal Watchdog:	An independent watchdog monitors signal flow. Flashing of LEDs1, 2 and 3 in a binary pattern indicate operational error
Dielectric test/ Galvanic separation:	4.0kVAC
Climate:	Class HUE, (DIN40040)
Temperature:	-20 to +70°C
Weight:	0.5kgs
Front protection:	IP21
Enclosure:	Flame retardant polycarbonate to UL94 (VO)

The unit meets IEC60093-504 and the relevant environmental and EMC tests specified in IEC60068/60092 and IEC61000/60533 respectively.

Dimensions

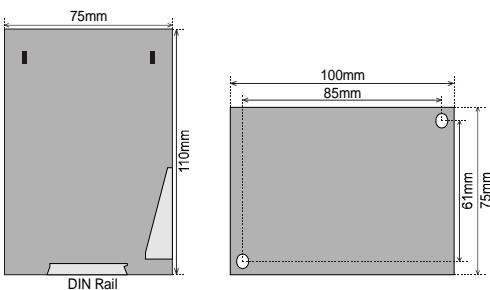

Description

The KCVF595E (3-wire) meet the protection requirements for short term paralleling of private generation to mains supply such as defined in G59 recommendations.

It combines under/over frequency, 3-phase under/over voltage and phase imbalance all in one single unit.

Trip points and other adjustments are made either via a hand held controller or via a computer.

Operational mode is controlled by two inputs from the generator and mains breakers. A different set of parameters can be set to allow for protection in both island operation and connected to mains.

An adjustable Supervision delay is fitted to overcome spurious tripping that may occur when synchronising with the mains.

Auxiliary supply and monitored inputs can be from the same source, as shown, or independent (DC).

Trip status is indicated by LED's and open collector outputs.

Connection Diagram
Three Phase 3-Wire connection

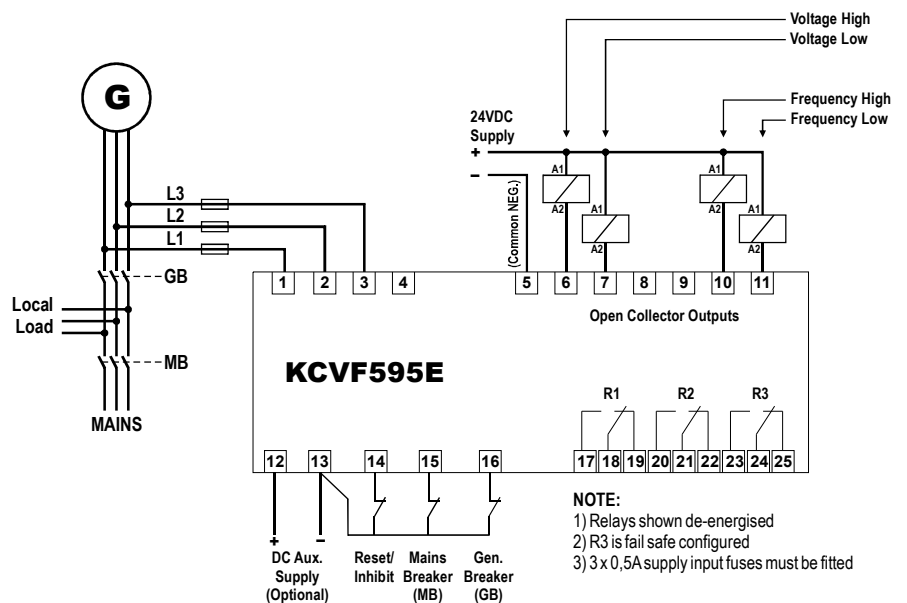





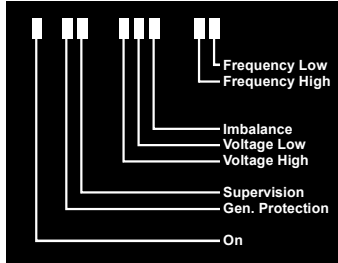
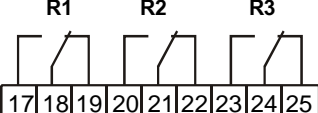

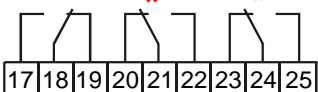
- NOTE:**
- 1) Relays shown de-energised
 - 2) R3 is fail safe configured
 - 3) 3 x 0,5A supply input fuses must be fitted

Operation

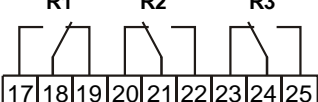
	<p>Auxiliary supply off All LED's off</p>		
---	---	--	---

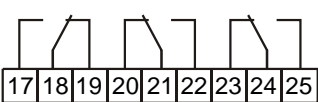
	<p>Aux. Supply on, unit inhibited</p>	 <p>Steady Green LED 1</p>	
--	---	--	---

Generator and mains breaker closed			
	<p>During supervision delay 1-10 seconds</p>	 <p>Flashing Green LED 4</p>	
	<p>After delay</p>	 <p>Steady Green LED's</p>	

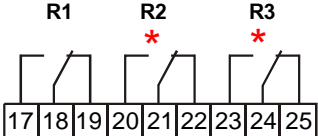
Any trip assuming generator continues to run			
		 <p>Red LED will illuminate depending upon the trip parameter</p>	
<p>If auxiliary supply is maintained, R1 and R3 latch and are reset by connecting terminals 12 and 13</p>			

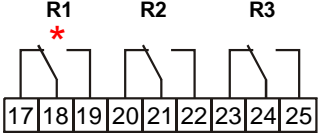
Any generator parameter trip			
		 <p>Red LED will illuminate depending upon the trip parameter</p>	
<p>If auxiliary supply is maintained, R1 and R3 latch and are reset by connecting terminals 12 and 13</p>			

* Indicates relay changing state

The MEGAcon policy is one of continuous improvement, consequently equipment supplied may vary in detail from this publication.



Programming and Events Log

Programming of KCVF595E can be achieved using Megacon's universal Programmer HHP1. The ID-protected programmer is powered directly from the unit and is used to program the parameters of any unit within the IS range. When plugged to the unit, the parameters unique to the unit will be displayed. This removes the need for expensive laptop computers. The HHP1 will comfortably fit into a pocket.

The ID-protected programmer is powered directly from the unit and is used to program the parameters of any unit within the IS range. When plugged into the unit, the parameters unique to the unit will be displayed. The HHP2 can also be used via the interface USB port to laptop computers.

Editing Procedure

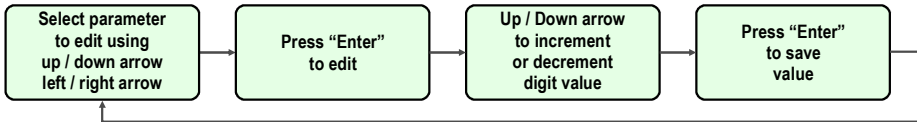

The optional HHPx will comfortably fit into a pocket. (85 x 114x 24mm)

Settable range of parameters for the KCVF595E unit is as shown:

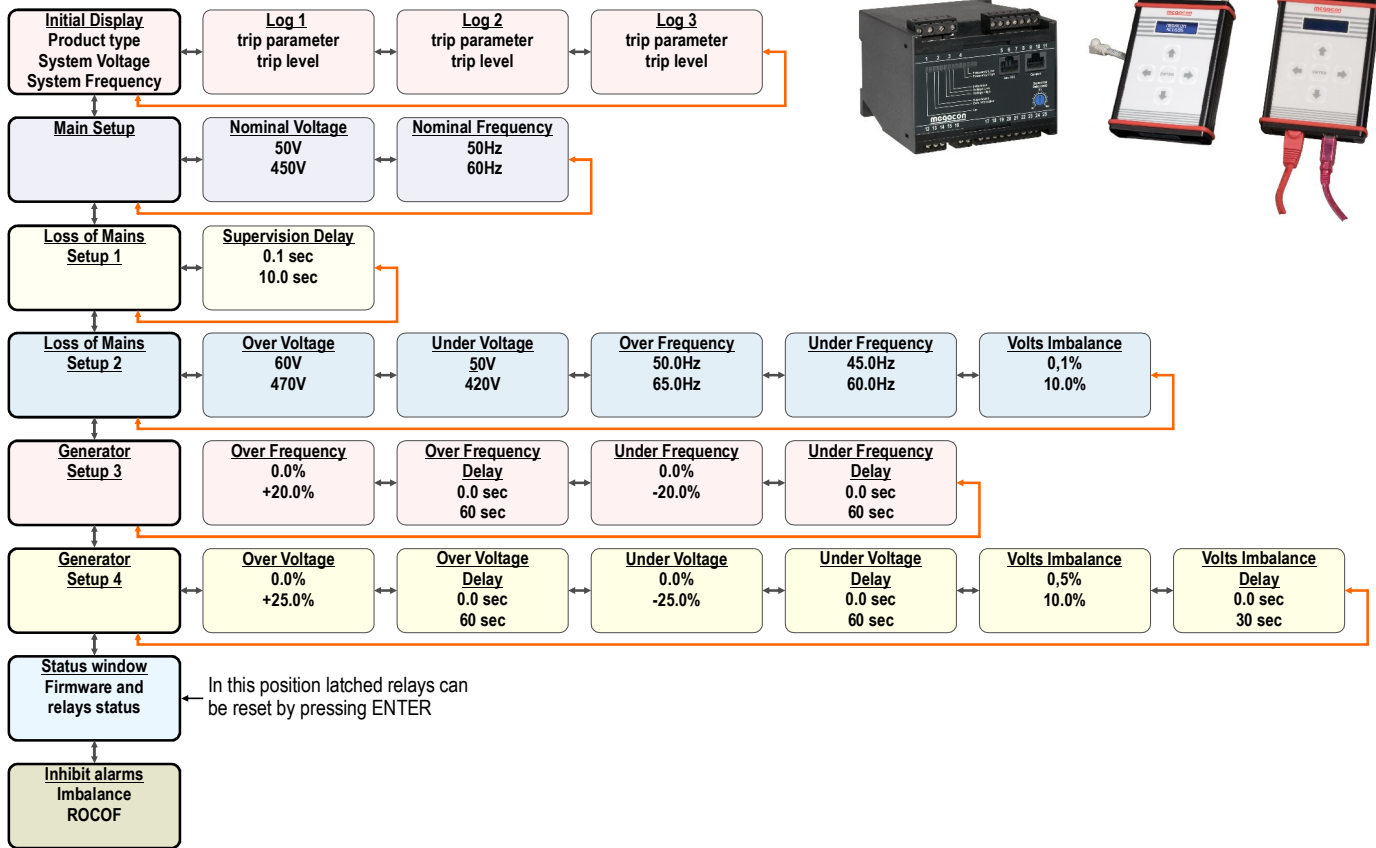

Programming and Events Log

Programming of KCVF595E can also be achieved using Megacon's configuration software. The optional HHP2 must be used to interface to laptop computers.

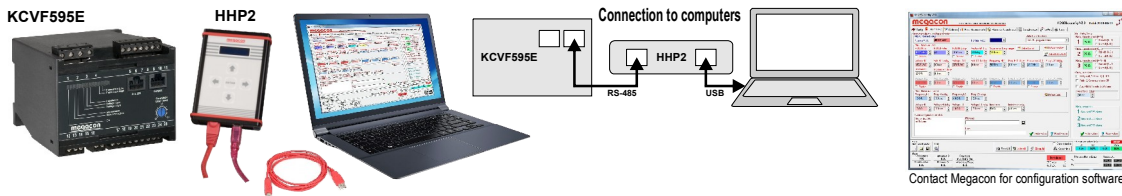

Contact Megacon for configuration software

The MEGAcon policy is one of continuous improvement, consequently equipment supplied may vary in detail from this publication.

ORDERING EXAMPLE:
 Type: KCVF595E
 Gen. Voltage: nom: 230V
 Optional unit: HHP2

