



- All-in-one unit, the COMPLETE solution
- G99 Loss of Mains Protection
- Supervision Delay and Event Log
- User configurable to Single or Three Phase (3-Wire) systems
- Digitally Controlled Operation
- Complies with the new G99 for ROCOF protection (Vector shift is deactivated)
- Tamper Proof configuration via the HHP1, HHP2 or via PC (HHP2 only)

**Specifications**

|                                       |   |
|---------------------------------------|---|
| Auxiliary Voltage:                    | Self powered from monitored voltage input   |
| Optional Auxiliary Voltage:           | 24 or 36-110VDC (Fuse 2A)   |
| Monitored Voltage input:              | 100-120, 200-240, 380-415 or 440-460VAC, 40-70Hz (Fuse 0,5A)  |
| Frequency Range:                      | 45-65Hz   |
| Relay Standard:                       | Latching relays as standard. User selectable to 3-180 secs auto reset of alarms   |
| Contact Rating:                       | AC: 100VA - 250V/2A max. DC: 50W - 100V/1A max.   |
| Open Collector Outputs:               | 30V DC max. - 500mA max.  |
| Settings:                             | See page 5 and 6  |
| Adjustments:                          | Supervision Delay: 0,1-10,0 secs (All other adjustments are made via the hand held controller HHP1 or HHP2)             |
| Internal Watchdog:                    | An independent watchdog monitors signal flow. Flashing of LEDs1, 2 and 3 in a binary pattern indicate operational error |
| Dielectric test/ Galvanic separation: | 4.0kVAC   |
| Climate:                              | Class HUE, (DIN40040)   |
| Temperature:                          | -20 to +70°C  |
| Weight:                               | 0.5kgs  |
| Front protection:                     | IP21  |
| Enclosure:                            | Flame retardant polycarbonate to UL94 (VO)  |

The unit meets IEC60093-504 and the relevant environmental and EMC tests specified in IEC60068/60092 and IEC61000/60533 respectively.

**Dimensions**

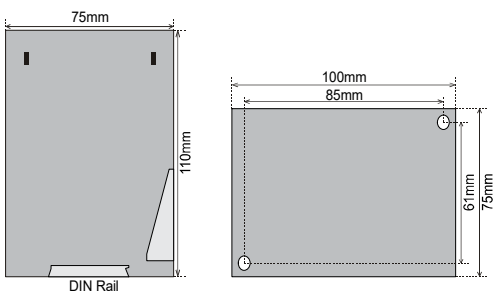

**Description**

The fully self-contained KCG597E provides precision protection against malfunction and human and operational hazards under loss of mains conditions for either single phase or three phase 3-wire systems.

The DIN rail mounted digitally controlled unit meets the protection requirements for generators connected to mains supply, such as defined in the G99 and similar recommendations.

Less wiring, no extra modules. Operating mode is selected by simple auxiliary contacts on the generator breaker and on the mains breaker. LEDs and open collector outputs indicate operating mode and "First Up" cause of trip.

State-of-the-art digital technology throughout, with quartz-controlled Loss of Mains detection. True RMS measurements.

**Loss of Mains Protection**

KCG597E will provide the following protection:

- 2 stage Over and Under Voltage
- 2 stage Over and Under Frequency
- Rate of Change of Frequency (ROCOF, df/dt)
- Vector Shift (step phase angle) (see note below)
- Voltage Imbalance
- Loss of Phase (<50ms, any phase <20V)

**Note:**

As Default, the Vector Shift is deactivated for G99 applications. The KCG59x accommodates the new Distribution Code Review Panel's proposal for Vector Shift immunity.

## Loss of Mains Protection

The Loss of Mains protection is provided with two separate protection circuits and these protection parameters can be set to suit all types of generator systems, both large and small:

- **Vector Shift** protection (deactivated for G99 applications)
- **Rate of Change of Frequency** protection (ROCOF)

Small generators, typically below 250kVA, will be more inclined to trip on a vector phase angle change than a ROCOF change, as these smaller systems are less able to sustain large load changes.

Conversely large generators may easily accept any extra loads following a mains failure situation without a large vector shift, but a change of frequency can be detected at the instant the extra load is demanded.

To overcome spurious operation, an adjustable supervision delay will inhibit the protection circuits immediately following paralleling with the mains supply.

### Principle of Vector Shift Protection

In order to produce power the prime mover will cause the generator rotor to lead with respect to the mains (Fig. 1). As the generator is "locked" to the grid supply, the frequency and therefore engine speed will be fixed to that of the grid.

The rotor lead angle will be continually changing by load changes on the generator whilst running in parallel with the mains, but these changes will be relatively slow in relationship to the vector shift a mains malfunction will cause. An interruption in the mains supply will cause a large shift in the degree of lead of the generator rotor thereby resulting in a voltage vector shift (Fig. 2).

At the instant of a mains failure, either a total or a momentary interruption, it may be desirable to continue generating power if essential services need to be maintained, **but from a safety point of view it is important to disconnect the generating set from the mains supply, as soon as possible.** Typical tripping time of the Loss of Mains function when a vector shift is detected is in the order of 50msecs. The vector shift is measured over a period equal to 2 cycles.

### Principle of Rate of Change of Frequency Protection

ROCOF detection relies on a change of load to bring about a rise or fall in the generator frequency. The  $df/dt$  detection process is looking for a change in two frequency levels and the tripping action is dependent on the time taken to move between these two levels.

Large generating sets may be able to sustain any connected loads immediately following a mains failure and the total Vector Shift imposed on the generator rotor may not be sufficient to trip the relay.

However, since the generator is no longer locked to the mains reference frequency, a change in load demand will cause a momentary change in speed followed by the governing system response to adjust the prime mover nominal speed. It is this change in the prime mover speed and hence the generator frequency that can be detected by the KCG597E.

The KCG597E uses an five cycle band to compare frequency difference and hence the rate of change can be determined. Typical trip times for a rate of change of frequency of 0.4Hz/sec. are in the order of 150mS.

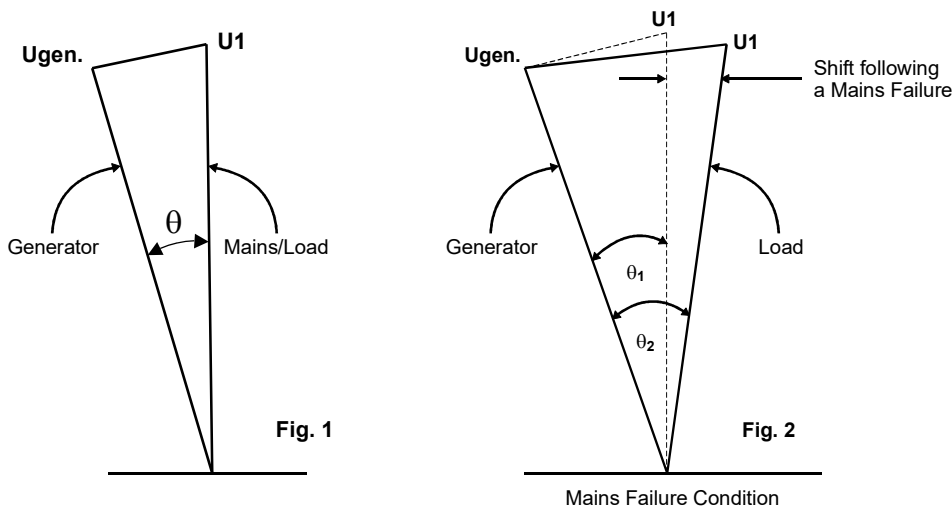

The MEGACON policy is one of continuous improvement, consequently equipment supplied may vary in detail from this publication.



## Description and Operation

### Automatic Supervision Delay

To prevent spurious tripping during synchronising to mains, the Loss of Mains protection is activated after the supervision delay has elapsed.

KCG597E is for three phase 3-wire LINE/LINE voltage input, and is to be connected directly or via a voltage transformer for use in applications such as:

|   |   |   |
|---|---|---|
| <b>Co-generation</b>                        | : | Single or multiple generators connected to a Utility grid                         |
| <b>Uninterruptible Power Supplies (UPS)</b> | : | Full or part time running, connected to or switching over from the Utility supply |
| <b>Base Load</b>                            | : | Full time base load supply, via Utility connection                                |
| <b>Peak lopping</b>                         | : | Part time peak load supply, via Utility connection                                |
| <b>Combined Heat and Power (CHP)</b>        | : | Full time load supply, normally via Utility connection with waste heat recovery   |

### Control Inputs

The KCG597E can be switched between inhibit and loss of mains mode using the control inputs. One N/C contact on the Generator Circuit Breaker and one on the Mains Circuit Breaker, wired as shown below.

### Reset, Inhibit.

With contact closed to terminal 14 all operation is inhibited. Contact closure to terminal 14 will also re-set any previous failure condition.

### Loss of Mains, G99 Mode

Loss of Mains mode is selected by opening of contacts to terminals 14, 15 and 16 (when both the generator circuit breaker and the mains circuit breaker are energised).

### Protective Relay Outputs

#### Relay R1, R2, R3 - Loss of Mains Mode

Relay R2 and R3 will de-energise and latch when ROCOF, Vector Shift or any electrical parameter exceeds **Loss of Mains Mode** set-points (non-latching relays optional).

Relay 1 energises and latches after trip. Automatic reset and reset delay is selectable via the HHPx.

## Connection Diagram

### Three Phase 3-Wire connection

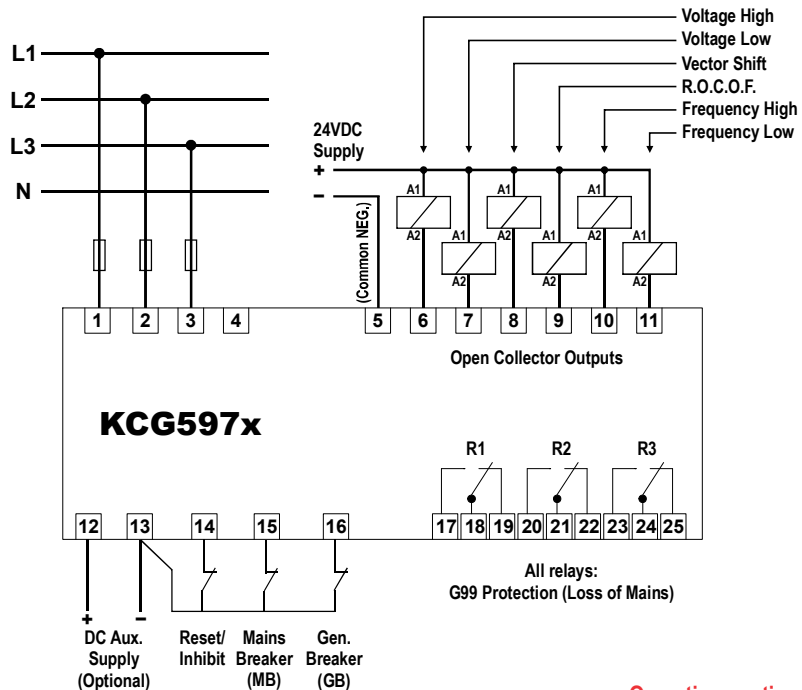

#### NOTE:

- 1) MB, GB, R1, R2 & R3 shown de-energised
- 2) R2 and R3 are fail safe configured
- 3) 3 x 0,5A supply input fuses must be fitted

Operation continues in next page

The MEGACON policy is one of continuous improvement, consequently equipment supplied may vary in detail from this publication.

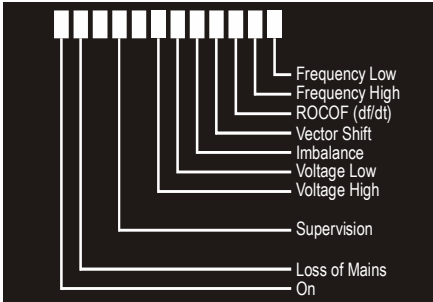
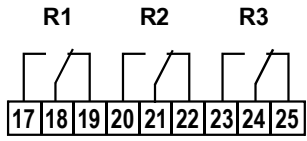
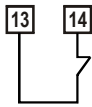
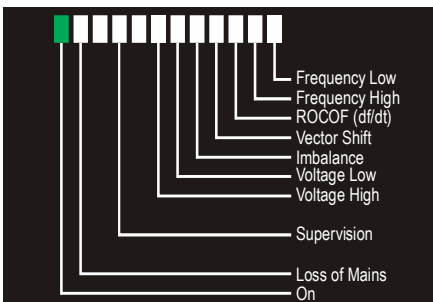
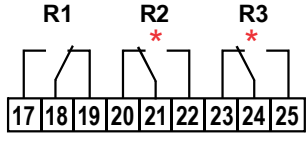
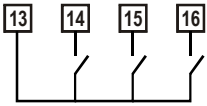
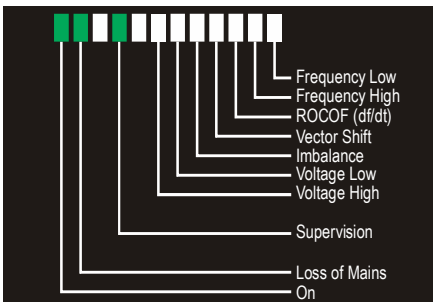
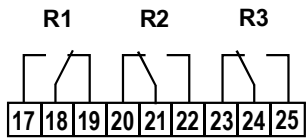
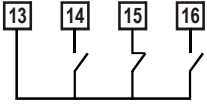
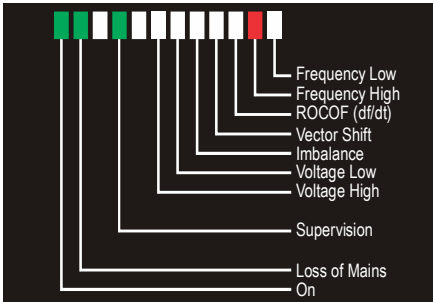
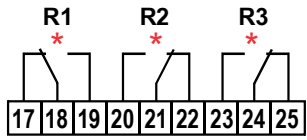

## Operation

|  |   |  |   |
|--|---|--|---|
|   | <p><b>Supply Off</b></p>  |    |    |
|  <p>Inhibit</p>                                   | <p><b>Supply On<br/>unit inhibited</b><br/>(LED1 flashing fast)</p> |    |    |
|  <p>MB closed - GB closed*</p>                   | <p><b>Loss of Mains<br/>Mode<br/>Normal operation</b></p>           |   |   |
|  <p>MB open - GB closed*</p>                    | <p><b>Loss of Mains<br/>Mode<br/>After failure</b></p>              |    |  |
| <p><b>GB:</b> Generator Breaker<br/><b>MB:</b> Mains Breaker<br/>* Use N.C. auxiliary contacts from breakers as control signal</p> |   | <p>A red LED indicates a "first up" trip parameter. For frequency and volt alarms the lamp will flash once for level 1 alarm and twice for level 2 alarm.</p> <p>The LED flashes during timer count down. If generator continues to run and supply is maintained, relays latch and are reset by linking terminals 13 and 14.</p> <p>Relay 2 and 3 are fail-safe configured<br/>* indicates a significant change of relay state</p> |   |

The MEGAcon policy is one of continuous improvement, consequently equipment supplied may vary in detail from this publication.



## Operation

### Setting the user adjustable parameters

The final settings for KCG597E should ideally be subject to agreement between the electricity supply authority and the operator of the generating system.

The default figures that Megacon normally set KCG597E at, in the absence of any definitive setting requirements, are as shown below for a 50Hz installation for 400V system voltage.

We have chosen these figures as a set of operating parameters, which are normally acceptable limits whereby the generating system is not subjected to being tripped off line by most usual variations in the grid operating parameters. These settings are generally suitable for operation in most areas.

| Mode                 | Sub Message            | Range  | Increments       | Default medium |  |
|----------------------|------------------------|--|------------------|----------------|--|
| <b>LOSS OF MAINS</b> | Volts Nominal          | 50 to 500V                                     | 0.1V steps       | 230V           |  |
|                      | Freq. Nominal          | 50 or 60Hz                                     | N/A              | 50Hz           |  |
|                      | R.O.C.O.F.             | 0.010 to 2.000Hz/sec                           | 0.01Hz           | 0.120Hz/sec    |  |
|                      | R.O.C.O.F. filter      | 5-10 x (20mS for 50Hz)<br>x (16,67mS for 60Hz) | 1                | 40             |  |
|                      | R.O.C.O.F. delay       | 0.010-1.00 sec                                 | 0,01 sec         | 0,50 sec       |  |
|                      | Vector Shift           | 0.5 to 15 degrees                              | 0.1 degrees      | 6 degrees      |  |
|                      | Supervision delay      | 0-10 sec                                       | 0.1 sec          | 10 sec         |  |
|                      | Volt High level 1      | 50 to 500V                                     | 0.1V steps       | 253V           |  |
|                      | Volt High lev.1 delay  | 0.0 to 25.0 sec                                | 0.1 sec          | 0,8 sec        |  |
|                      | Volts Low level 1      | 50 to 500V                                     | 0.1V steps       | 184V           |  |
|                      | Volts Low lev.1 delay  | 0.0 to 25.0 sec                                | 0.1 sec          | 2.3 sec        |  |
|                      | Freq. High level 1     | 50 to 70Hz                                     | 0.1Hz steps      | 52.0Hz         |  |
|                      | Freq. High lev.1 delay | 0.0 to 90.0 sec                                | 0.1 sec          | 0,3 sec        |  |
|                      | Freq. Low level 1      | 60 to 40Hz                                     | 0.1Hz steps      | 47.5Hz         |  |
|                      | Freq. Low lev.1 delay  | 0.0 to 25.0 sec                                | 0.1 sec          | 19.8 sec       |  |
|                      | Imbalance              | 0.1-50%  | 0.1% steps       | 20%            |  |
|                      | Imbalance delay        | 0.0 to 25.0 sec                                | 0.1 sec          | 24.8 sec       |  |
|                      | Volt High level 2      | 50 to 500V                                     | 0.1V steps       | disabled       |  |
|                      | Volt High lev.2 delay  | 0.0 to 25.0 sec                                | 0.1 sec          | -              |  |
|                      | Volts Low level 2      | 50 to 500V                                     | 0.1V steps       | disabled       |  |
|                      | Volts Low lev.2 delay  | 0.0 to 25.0 sec                                | 0.1 sec          | -              |  |
|                      | Freq. High level 2     | 50 to 70Hz                                     | 0.1Hz steps      | disabled       |  |
|                      | Freq. High lev.2 delay | 0.0 to 90.0 sec                                | 0.1 sec          |                |  |
|                      | Freq. Low level 2      | 60 to 40Hz                                     | 0.1Hz steps      | 47.0Hz         |  |
|                      | Freq. Low lev.2 delay  | 0.0 to 25.0 sec                                | 0.1 sec          | 0.3 sec        |  |
|                      | <b>Trip times:</b>     |  |                  |                |  |
|                      |                        | R.O.C.O.F.                                     | : 150mS(average) |                |  |
|                      |                        | Vector Shift                                   | : less than 50mS |                |  |

### Hand held programmer HHP1 or HHP2

When the optional hand held programmer HHPx is connected to the KCG597E comport the user is able to set individual protection parameters to suit the application, amend set-points, view the events log and read the system voltage and frequency on the back-lit LCD screen. (see next page)

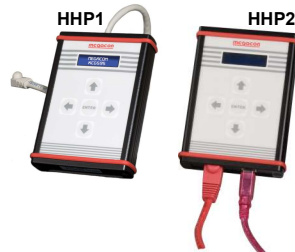

The MEGACON policy is one of continuous improvement, consequently equipment supplied may vary in detail from this publication.



## Programming and Events Log

Parameter set-points and timers are user settable via the optional Megacon hand held programmer HHP1 or HHP2. On HHP's back-lit LCD-screen the system voltage and frequency, relay status and history of events can also be viewed. Trip of relays can be inhibited during testing of Loss of Mains parameters (Imbalance and ROCOF/Vector shift).

The ID-protected programmer is powered directly from the unit and is used to program the parameters of any unit within the IS range. When plugged into the unit, the parameters unique to the unit will be displayed. The HHP2 can also be used via the interface USB port to laptop computers. (see next page)

## Editing Procedure

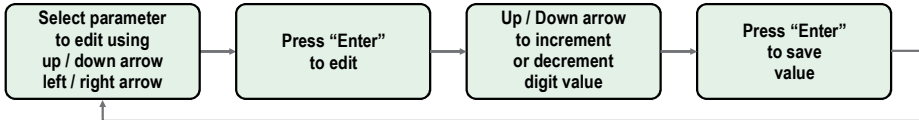

The optional HHPx will comfortably fit into a pocket. (85 x 114x 24mm)



## Settable range of parameters for the KCG597E unit is as shown:

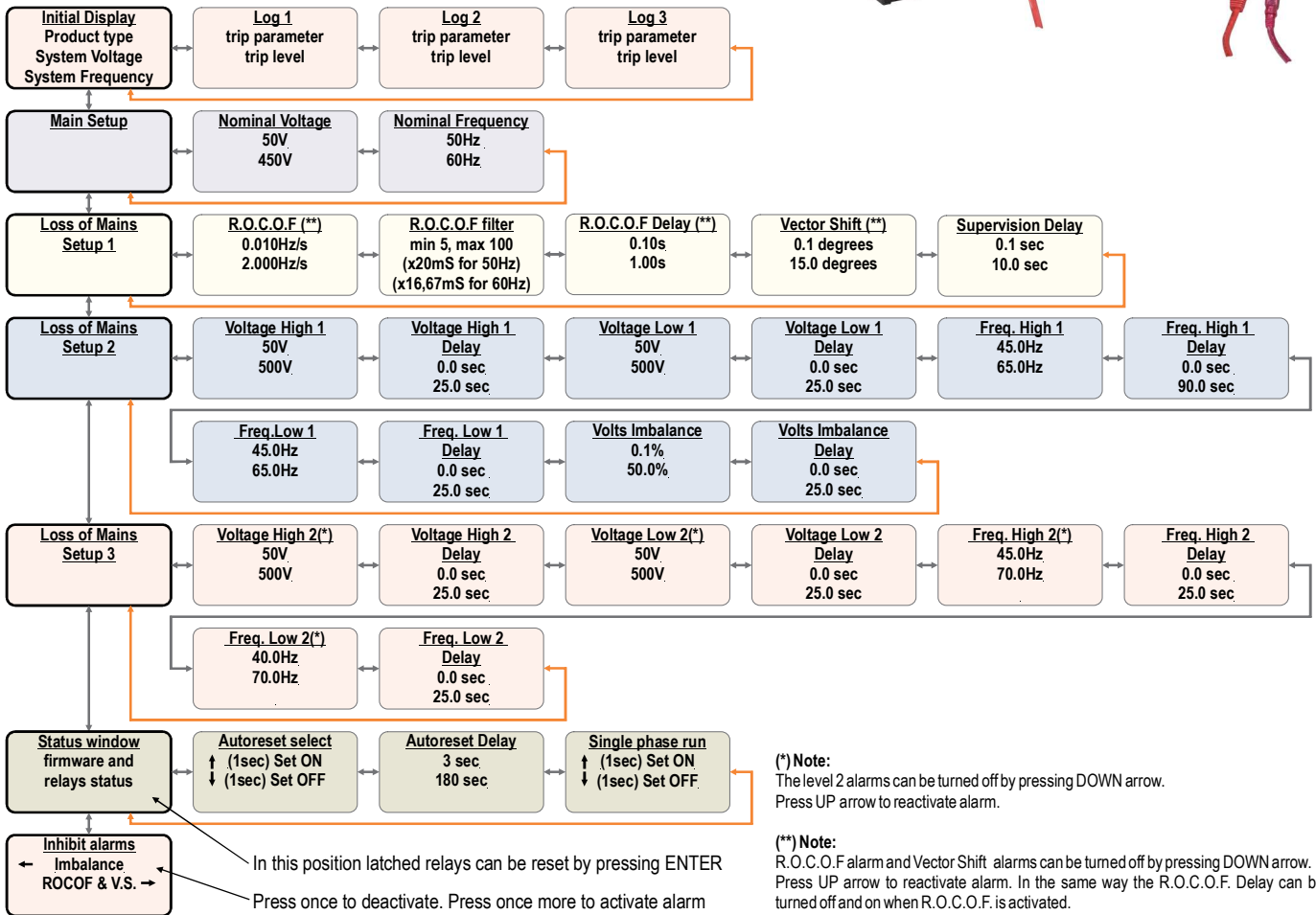

The MEGAICON policy is one of continuous improvement, consequently equipment supplied may vary in detail from this publication.



## Programming and Events Log

Programming of KCG597E can also be achieved using Megacon's configuration software. The optional HHP2 must be used to interface to laptop computers.

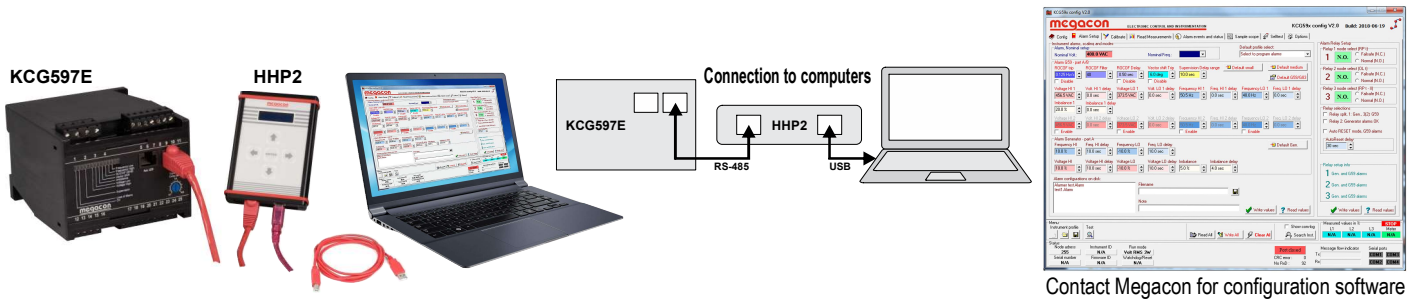

## Handheld firmware update programmer

HPD1 provides simple and convenient updating of pre-installed KCG59x Loss of Mains protection equipment to comply with G99 guidelines.

The HPD1 connects to the KCG59x "Comport" interface via a RJ45 lead and is powered from the KCG59x internal low voltage supply rail. The device is "hot pluggable", i.e. the KCG59x does not need to be powered down before connecting. The update code is stored internally within the device and there is no requirement for a PC or laptop when updating.

LED indicators show the status of the equipment and whether the firmware currently installed in the connected KCG59x is older, newer or the same revision as that stored in the programmer.

Installation of the new ENA (Energy Network Association) compliant firmware is accomplished by a single press of the button marked "UPDATE". Optional ROCOF/VS or full LV or HV G99 parameters can be automatically programmed at the same time.

Future firmware updates can be loaded onto the device via a plug-n-play USB connection. Windows software is included to interrogate the programmer and replace the stored code with a later revision which will be downloadable from the Megacon website.



## Potential Problem Areas

Although the Loss of Mains protection guarantees fast and reliable detection of mains failure in nearly all operational conditions when a generator running in parallel with the mains supply, certain cases may cause the KCG597E to malfunction.

- 1:
  - If there is NO or very little change in the **vector angle** at a mains interruption then the relay may not operate. This situation can arise if the amount of power exported to the grid system is very low and at a mains interruption there is no discernible extra consumer load imposed on the generating set.
  - From the above it should be noted that the generator should aim to export at least 10-20% of the generated power to the grid system in order to guarantee some change in load in the event of a mains interruption.
  - Conversely if the generating set is used for peak lopping and is not exporting power to the grid system, the operator should ensure that the equivalent of 10-20% of the generator load capability is imported from the grid, so that in the event of a mains interruption the generator will immediately take up that load and so cause the relay to operate.
  - For the **ROCOF** detection to operate successfully the governor of the prime mover must be set to allow a speed droop of around 5% between no load and full load.
  - If close tolerance governors with only small droop characteristics are fitted, the change in frequency may be so small that there is no appreciable change to be detected.
- 2:
  - Spurious tripping of the relay when the mains supply has been shown to be stable can usually be attributed to the operational characteristics of the generating set.
  - If large extra loads are added to the generator then this will result in a vector shift being detected and the relay may trip.
  - The ramp rate of the generator prime mover may be set at a very fast level, again causing a large vector shift and frequency changes.
  - Another possibility is that local consumers connected to the grid system are switching in large loads which are resulting in the generator responding much quicker than the grid supply to changing load demands.
  - In these cases it will be needed to "fine tune" the prime mover response and ramp rates to allow for these disturbances.
  - In the case of large load demands, the operator may need to arrange for a more progressive connection and disconnection of loads to prevent large vector shifts or arrange to inhibit the KCG597E whilst switching large loads.

The MEGACON policy is one of continuous improvement, consequently equipment supplied may vary in detail from this publication.

**ORDERING EXAMPLE:**

|                |           |
|----------------|-----------|
| Type:          | KCG597E   |
| Gen. Voltage:  | nom: 400V |
| Optional unit: | HHP2      |

