



- Precision true rms measurement of Watt or VAR, not affected by heavily distorted current or voltage waveform
- For single phase, 3-wire or 4-wire, 32-70Hz systems
- For use with 1A or 5A current transformers
- Linear scale with normal or displaced zero

Specifications

Input Voltage:	100-120, 200-240, 380-415, 440-480VAC, 32-70Hz
Current Input:	1A or 5A C.T.
Scaling:	Standard is with 10% reverse scale
Temperature:	-20 to +70°C
Weight:	0.5kgs
Front protection:	IP52 (IP54 or IP65 optional)

The unit meets IEC60092-504 and the relevant environmental and EMC tests specified in IEC60068/60092 and IEC61000/60533 respectively, to comply with the requirements of the major Classification Societies.

Description

The digitally controlled DQ96x measures unbalanced and balanced active power (W) or reactive power (VAR) in single phase, 3-wire or 4-wire (with neutral) three phase systems.

The unit measures the zero point crossing and the true rms current and voltage value, and its accuracy is independent of any wave form distortion.

This DIN96 class 1,5 meter has low-reflection glass to ease reading at a distance.

The instruments are individually scaled and calibrated, and can be supplied with a displaced zero to monitor reverse power.

Shown below are designations for the available circuit configurations:

ACTIVE POWER (W)

- DQ96-1W2E - 1 element, single phase
- DQ96-1W3E - 1 element, 3 phase, 3 wire, balanced load
- DQ96-1W4E - 1 element, 3 phase, 4 wire, balanced load
- DQ96-2W3E - 2 element, 3 phase, 3 wire, unbalanced load
- DQ96-3W3E - 3 element, 3 phase, 3 wire, unbalanced load
- DQ96-3W4E - 3 element, 3 phase, 4 wire, unbalanced load

REACTIVE POWER (VAR)

- DQ96-1R2E - 1 element, single phase
- DQ96-1R3E - 1 element, 3 phase, 3 wire, balanced load
- DQ96-1R4E - 1 element, 3 phase, 4 wire, balanced load
- DQ96-2R3E - 2 element, 3 phase, 3 wire, unbalanced load
- DQ96-3R3E - 3 element, 3 phase, 3 wire, unbalanced load
- DQ96-3R4E - 3 element, 3 phase, 4 wire, unbalanced load

SCALING

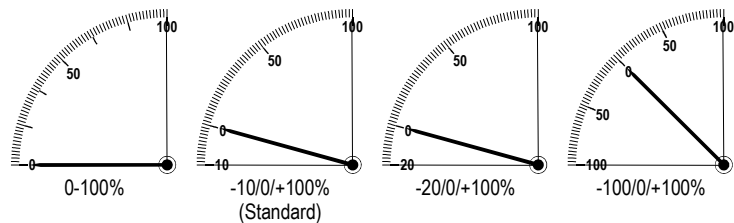

Dimensions

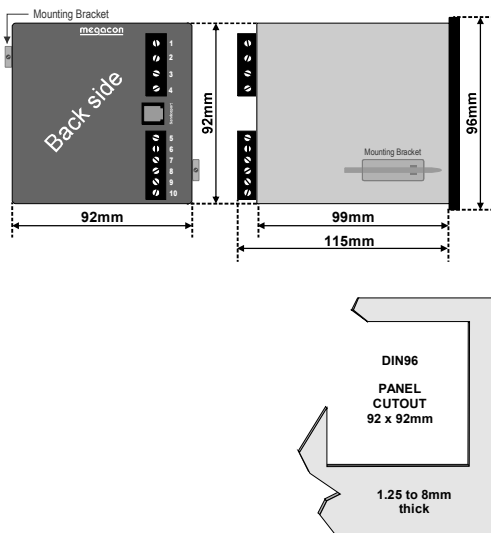

ACTIVE POWER (W)

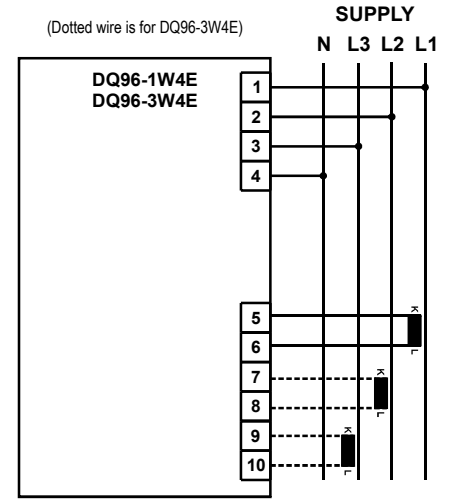
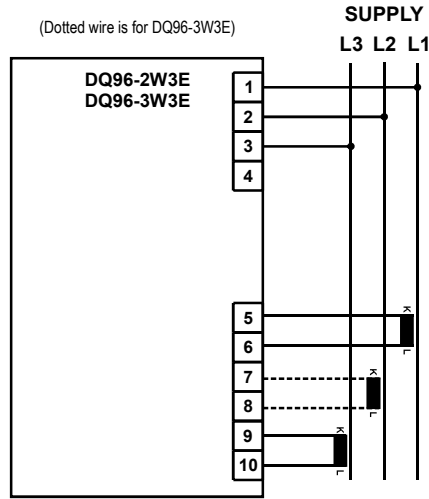
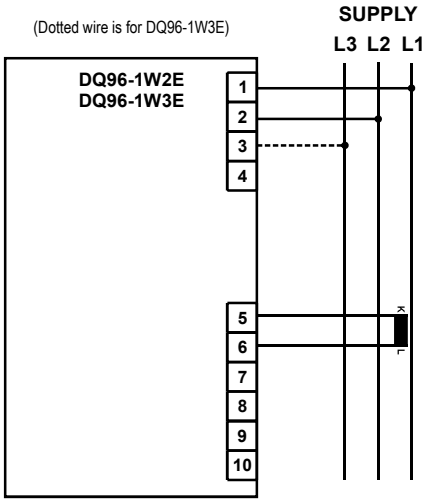

REACTIVE POWER (Var)

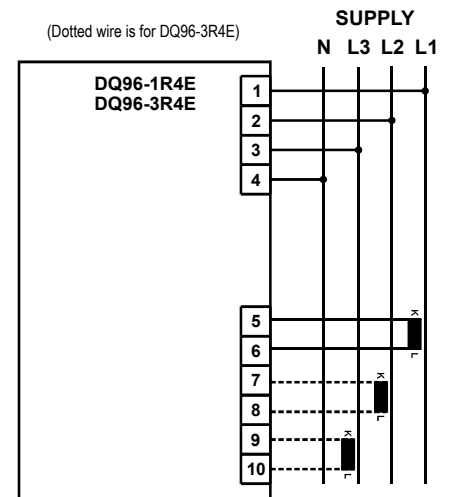
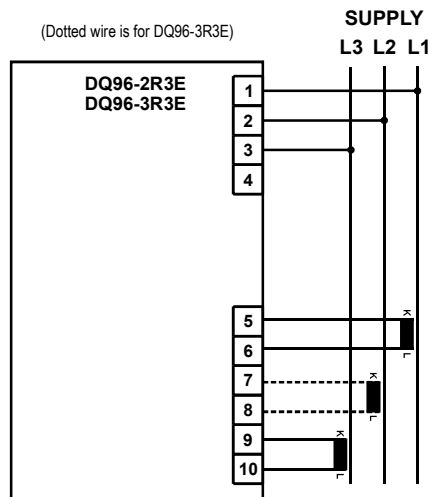
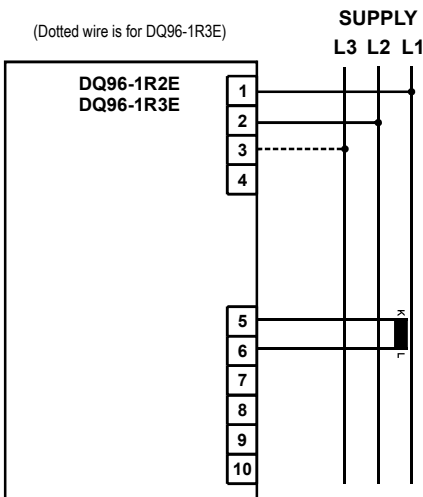

The MEGACON policy is one of continuous improvement, consequently equipment supplied may vary in detail from this publication.

ORDERING EXAMPLE:

Type:	DQ96-2W3E
Aux. Supply:	200-240VAC
Input Current:	800/5A
Range:	-30/0/+300kW

